



3.1 - CON RETENCIÓN

ASSA ABLOY

BISAGRAS
CON RETENCIÓN | SERIE MARÉVA

SERIE MARÉVA

Vidrio 6/8 mm

BISAGRA CON 2 AGUJEROS DE FIJACIÓN RETENCIÓN REGULABLE

Características técnicas:

- Base con orificios ranurados que permiten ajuste en profundidad
- Tornillos y base ocultos para una mejor estética
- Apertura de 180°
- Montaje con muesca 3160BE
- Peso máximo por hoja: 40 kg
- Sistema patentado
- Acabados de alta calidad
- Cumple norma EN1670 grado 5
- 7 años de garantía



3160.0RCV

Acabados:

Plata brillo	1890.2R PB
Plata mate	1890.2R PM
Efecto inox mate	1890.2R IN



BREVETÉ PATENTÉ
SYSTÈMES BREVETÉS PATENTED SYSTEM

- Système de réglage d'angle précis
- Système anti-bruit
- Adjustment System of the door angle
- Anti-noise system

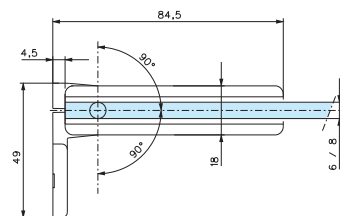
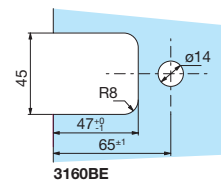
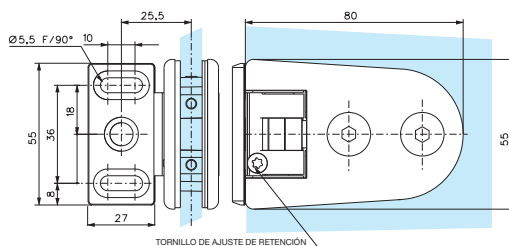

BISAGRA VIDRIO/VIDRIO RETENCIÓN REGULABLE

Características técnicas:

- Apertura de 180°
- Montaje con muesca 3160BE
- Material: bronce. Eje inoxidable
- Peso máximo por hoja: 40 kg



3162.0R

Acabados:

Plata brillo	1895.R PB
Plata mate	1895.R PM
Efecto inox mate	1895.R IN

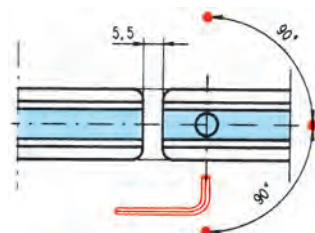
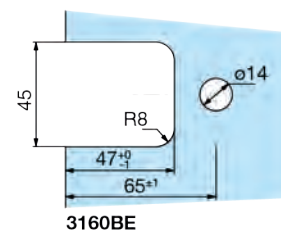
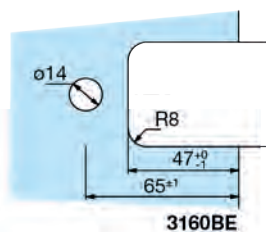
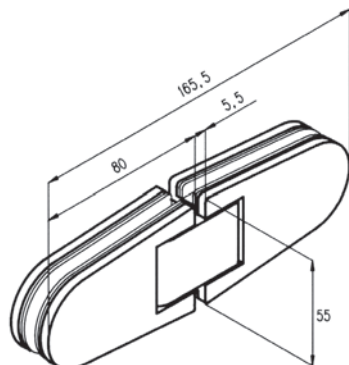

**BISAGRA VIDRIO/VIDRIO
EN ÁNGULO DE 90°
RETENCIÓN REGULABLE**

3164.0R

Características técnicas:

- Apertura de 180°
- Montaje con muesca 3164BE para la hoja móvil y 3160 BE para la hoja fija
- Material: bronce. Eje inoxidable
- Peso máximo por hoja: 40 kg
- Para puerta a 90° con relación a la hoja fija

Acabados:

Plata brillo	1892.R PB
Plata mate	1892.R PM
Efecto inox mate	1892.R IN

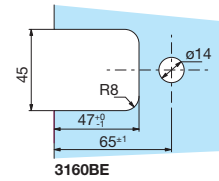

Hoja fija

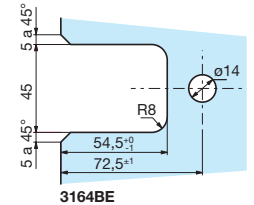

Hoja móvil

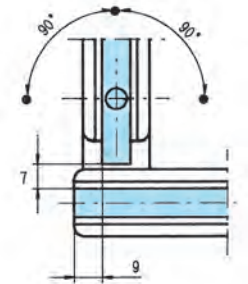
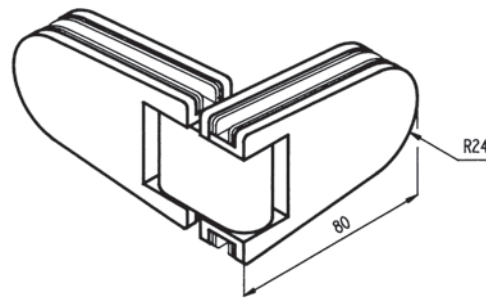

COMPLEMENTOS MARÉVA

**PIEZA DE FIJACIÓN
PARA HOJA FIJA**

3165.0

Características técnicas:

- Montaje con muesca M302
- Material: bronce

Acabados:

Plata brillo	1896 PB
Plata mate	1896 PM
Efecto inox mate	1896 IN

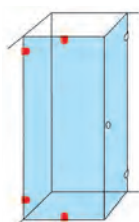
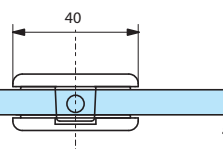
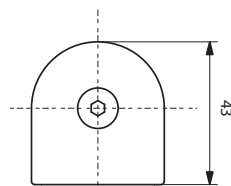
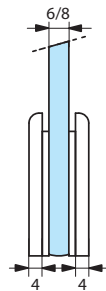
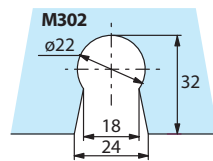

**PIEZA DE FIJACIÓN CON
ESCUADRA PARA HOJA FIJA**

3085.0

Características técnicas:

- Montaje con muesca M302 o 3065E
- Material: bronce

Acabados:

Plata brillo	1896.1R PB
Plata mate	1896.1R PM
Efecto inox mate	1896.1R IN

